

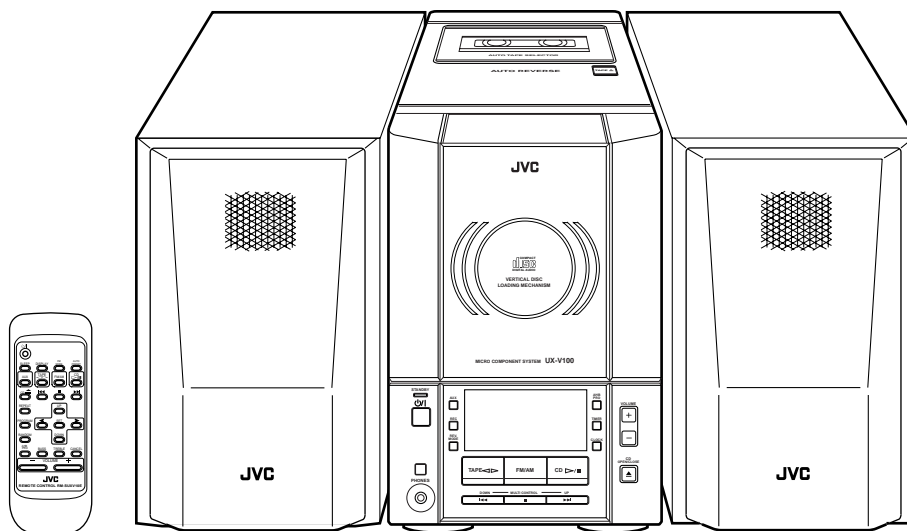

# JVC

## MICRO COMPONENT SYSTEM

# UX-V100

 — Consists of CA-UXV100 and SP-UXV100.

COMPACT  
**disc**  
DIGITAL AUDIO

## INSTRUCTIONS

**For Customer Use:**

Enter below the Model No. and Serial No. which are located either on the rear, bottom or side of the cabinet. Retain this information for future reference.

Model No. \_\_\_\_\_

Serial No. \_\_\_\_\_

GVT0056-008A

[B]



## Warnings, Cautions and Others

### IMPORTANT for the U.K.

**DO NOT** cut off the mains plug from this equipment. If the plug fitted is not suitable for the power points in your home or the cable is too short to reach a power point, then obtain an appropriate safety approved extension lead or consult your dealer.

**BE SURE** to replace the fuse only with an identical approved type, as originally fitted.

If nonetheless the mains plug is cut off ensure to remove the fuse and dispose of the plug immediately, to avoid a possible shock hazard by inadvertent connection to the mains supply.

If this product is not supplied fitted with a mains plug then follow the instructions given below:

#### IMPORTANT:

**DO NOT** make any connection to the terminal which is marked with the letter E or by the safety earth symbol or coloured green or green-and-yellow.

The wires in the mains lead on this product are coloured in accordance with the following code:

Blue : Neutral  
Brown : Live

As these colours may not correspond with the coloured markings identifying the terminals in your plug proceed as follows:

The wire which is coloured blue must be connected to the terminal which is marked with the letter N or coloured black.

The wire which is coloured brown must be connected to the terminal which is marked with the letter L or coloured red.

**IF IN DOUBT - CONSULT A COMPETENT ELECTRICIAN.**

### Caution — ⏻/I switch!

Disconnect the mains plug to shut the power off completely. The ⏻/I switch in any position does not disconnect the mains line. The power can be remote controlled.

## IMPORTANT FOR LASER PRODUCTS

### REPRODUCTION OF LABELS

- ① CLASSIFICATION LABEL, PLACED ON REAR ENCLOSURE

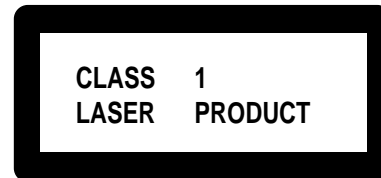

- ② WARNING LABEL, PLACED INSIDE THE UNIT

<b>DANGER:</b> Invisible laser radiation when open and interlock failed or defeated. AVOID DIRECT EXPOSURE TO BEAM. (e)	<b>WARNING:</b> Osynlig laserstrålning när denna del är öppnad och spärren är urkopplad. Betrakta ej strålen. (s)	<b>ADVARSEL:</b> Usynlig laserstrålning ved åbning, når sikkerhedsafbrydere er ude af funktion. Undgå udsættelse for stråling (d)	<b>VARO:</b> Avattaessa ja suojalukitus ohitettaessa olet alttiina näkymättömälle lasersäteilylle. Älä katso säteeseen. (f)
---	---	---	---

1. CLASS 1 LASER PRODUCT
2. **DANGER:** Invisible laser radiation when open and interlock failed or defeated. Avoid direct exposure to beam.
3. **CAUTION:** Do not open the top cover. There are no user serviceable parts inside the Unit; leave all servicing to qualified service personnel.

### CAUTION

To reduce the risk of electrical shocks, fire, etc.:

1. Do not remove screws, covers or cabinet.
2. Do not expose this appliance to rain or moisture.





**Caution: Proper Ventilation**

To avoid risk of electric shock and fire, and to prevent damage, locate the apparatus as follows:

1 Front:

No obstructions and open spacing.

2 Sides/ Top/ Back:

No obstructions should be placed in the areas shown by the dimensions below.

3 Bottom:

Place on the level surface. Maintain an adequate air path for ventilation by placing on a stand with a height of 10 cm or more.

Front view

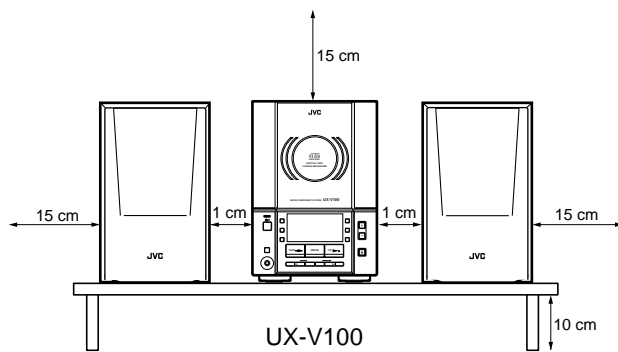

Side view

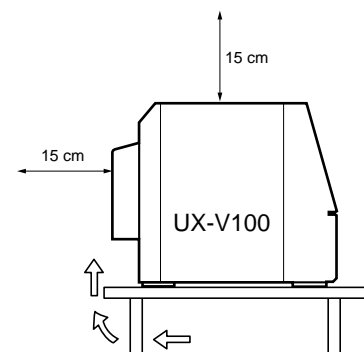



## SAFETY INSTRUCTIONS “SOME DOS AND DON'TS ON THE SAFE USE OF EQUIPMENT”

This equipment has been designed and manufactured to meet international safety standards but, like any electrical equipment, care must be taken if you are to obtain the best results and safety is to be assured.

\*\*\*\*\*

Do read the operating instructions before you attempt to use the equipment.

Do ensure that all electrical connections (including the mains plug, extension leads and interconnections between pieces of equipment) are properly made and in accordance with the manufacturer's instructions. Switch off and withdraw the mains plug when making or changing connections.

Do consult your dealer if you are ever in doubt about the installation, operation or safety of your equipment.

Do be careful with glass panels or doors on equipment.

\*\*\*\*\*

DON'T continue to operate the equipment if you are in any doubt about it working normally, or if it is damaged in any way—switch off, withdraw the mains plug and consult your dealer.

DON'T remove any fixed cover as this may expose dangerous voltages.

DON'T leave equipment switched on when it is unattended unless it is specifically stated that it is designed for unattended operation or has a standby mode.

Switch off using the switch on the equipment and make sure that your family know how to do this.

Special arrangements may need to be made for infirm or handicapped people.

DON'T use equipment such as personal stereos or radios so that you are distracted from the requirements of traffic safety. It is illegal to watch television whilst driving.

DON'T listen to headphones at high volume as such use can permanently damage your hearing.

DON'T obstruct the ventilation of the equipment, for example with curtains or soft furnishings.

Overheating will cause damage and shorten the life of the equipment.

DON'T use makeshift stands and NEVER fix legs with wood screws — to ensure complete safety always fit the manufacturer's approved stand or legs with the fixings provided according to the instructions.

DON'T allow electrical equipment to be exposed to rain or moisture.

### ABOVE ALL

- NEVER let anyone, especially children, push anything into holes, slots or any other opening in the case — this could result in a fatal electrical shock.;
- NEVER guess or take chances with electrical equipment of any kind — it is better to be safe than sorry!





Thank you for purchasing the JVC Micro Component System.  
 We hope it will be a valued addition to your home, giving you years of enjoyment.  
 Be sure to read this instruction manual carefully before operating your new stereo system.  
 In it you will find all the information you need to set up and use the system.  
 If you have any query that is not answered by the manual, please contact your dealer.

## Features

Here are some of the things that make your System both powerful and simple to use.

- The controls and operations have been designed to make them very easy to use, freeing you to just enjoy the music.
  - With JVC's **COMPU PLAY** you can turn on the System and automatically start the Radio, Cassette deck or CD Player with a single touch.
- The System incorporates Active Hyper Bass PRO circuitry to faithfully reproduce low frequency sounds.
- Forty-five-station preset capability (30 FM and 15 AM (MW/LW)) in addition to auto-seek and manual tuning.
- Versatile CD options include repeat, random and program play.
- Timer functions; Daily Timer, Recording Timer and Sleep Timer.
- Auto-reverse tape function.
- You can connect an audio equipment — used only as a playback device.



## How This Manual Is Organized

- Basic information that is the same for many different functions – e.g. setting the volume – is given in the section “Common Operations”, and not repeated under each function.
- The names of buttons/controls and display messages are written in all capital letters: e.g. TAPE, “NO DISC”.

## IMPORTANT PRECAUTIONS

### 1 Installation of the System

- Select a place which is level, dry and neither too hot nor too cold. (Between 5°C and 35°C.)
- Leave sufficient distance between the System and a TV.
- Do not use the System in a place subject to vibrations.

### 2 Power cord

- Do not handle the power cord with wet hands!
- Some power is always consumed as long as the power cord is connected to the wall outlet.
- When unplugging the System from the wall outlet, always pull the plug, not the power cord.

### 3 Malfunctions, etc.

- There are no user serviceable parts inside. In case of a system failure, unplug the power cord and consult your dealer.
- Do not insert any metallic object into the System.

# Table of Contents

Features .....	1	Using the Cassette Deck (Recording) .....	14
How This Manual Is Organized .....	1	Using External Equipment .....	16
IMPORTANT PRECAUTIONS .....	1	Using the Timers .....	17
Getting Started .....	2	Care and Maintenance .....	20
Common Operations .....	6	Troubleshooting .....	21
Using the Tuner .....	8	Specifications .....	22
Using the CD Player .....	10		
Using the Cassette Deck (Listening to a Tape) .....	13		





# Getting Started

## Accessories

Make sure that you have all of the following items, which are supplied with the System.

- AC Power Cord (1)
- AM Loop Antenna (1)
- Remote Control (1)
- Batteries (2)
- FM Wire Antenna (1)

If any of these items are missing, contact your dealer immediately.

## How to Put Batteries in the Remote Control

Match the polarity (+ and -) on the batteries with the + and - markings in the battery compartment.

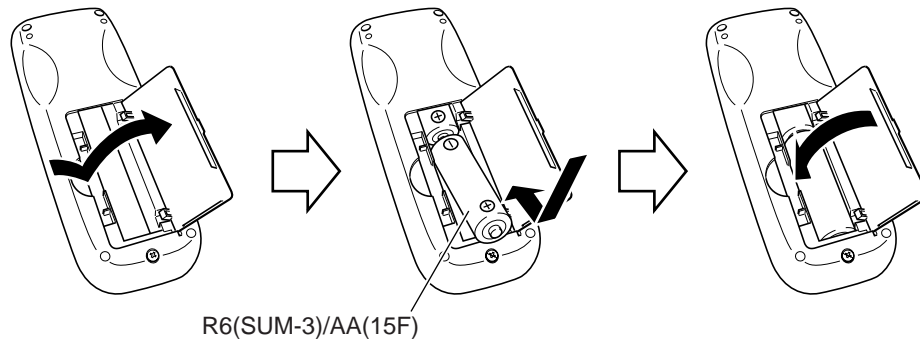

### CAUTION: Handle batteries properly.

To avoid battery leakage or explosion:

- Remove batteries when the Remote Control will not be used for a long time.
- When you need to replace the batteries, replace both batteries at the same time with new ones.
- Do not use an old battery with a new one.
- Do not use different types of batteries together.

## Using the Remote Control

The Remote Control makes it easy to use many of the functions of the System from a distance of up to 7 m away. You need to point the Remote Control at the remote sensor on the System's front panel.

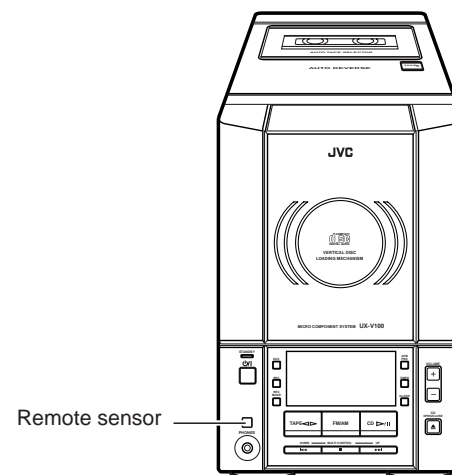



**CAUTION: Make all connections before plugging the System into an AC power outlet.**

## Connecting the FM Antenna

Rear Panel of the Unit

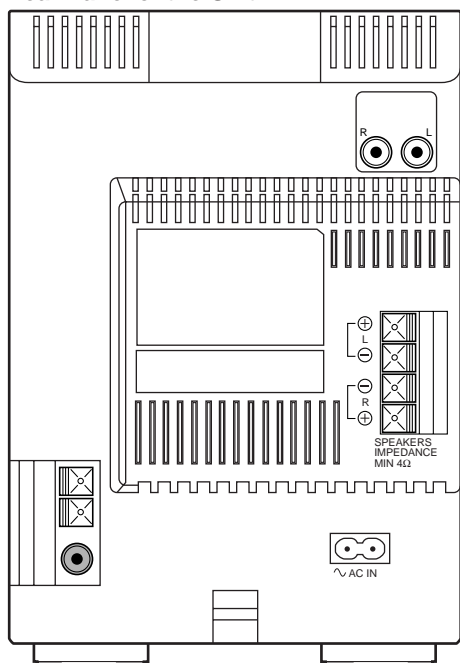

### Using the supplied Wire Antenna

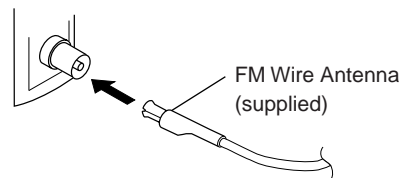

### Using the coaxial type connector (not supplied)

A 75 Ω antenna with coaxial connector (IEC or DIN 45325) should be connected to the FM (75 Ω) COAXIAL terminal.

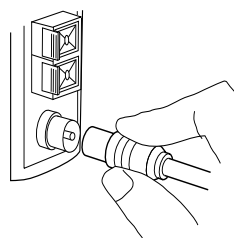

If reception is poor, connect the outdoor antenna.

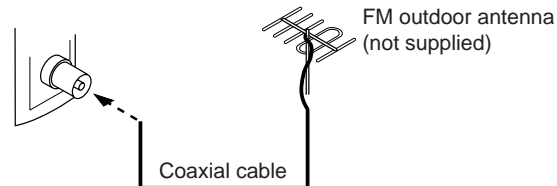

**Note:** Before attaching a 75 Ω coaxial lead (the kind with a round wire going to an outdoor antenna), disconnect the supplied FM Wire Antenna.

## Connecting the AM (MW/LW) Antenna

Rear Panel of the Unit

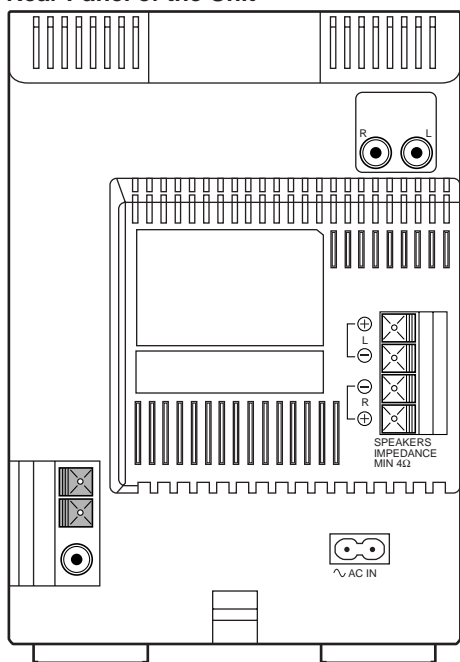

AM Loop Antenna (supplied)

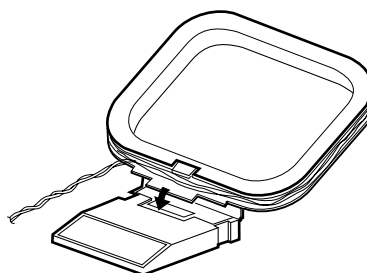

Attach the AM loop to its base by snapping the tabs on the loop into the slot in the base.

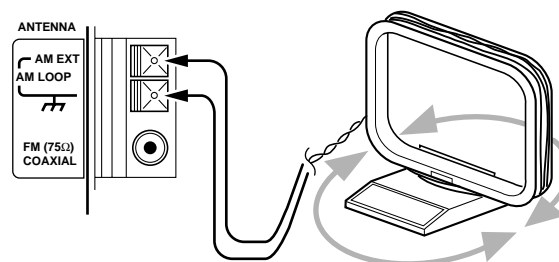

Turn the loop until you have the best reception.

**CAUTION:**  
To avoid noise, keep antennas away from the System, the connecting cord and the AC power cord.





**CAUTION: Make all connections before plugging the System into an AC power outlet.**

## Connecting the Speakers

For each speaker, connect one end of the speaker wire to the speaker terminals on the back of the System.

1. Open each of the terminals and insert the speaker wires firmly, then close the terminals.
2. Connect the red (+) and black (-) wires of the right side speaker to the red (+) and black (-) terminals marked R on the System. Connect the red (+) and black (-) wires of the left side speaker to the red (+) and black (-) terminals marked L on the System.

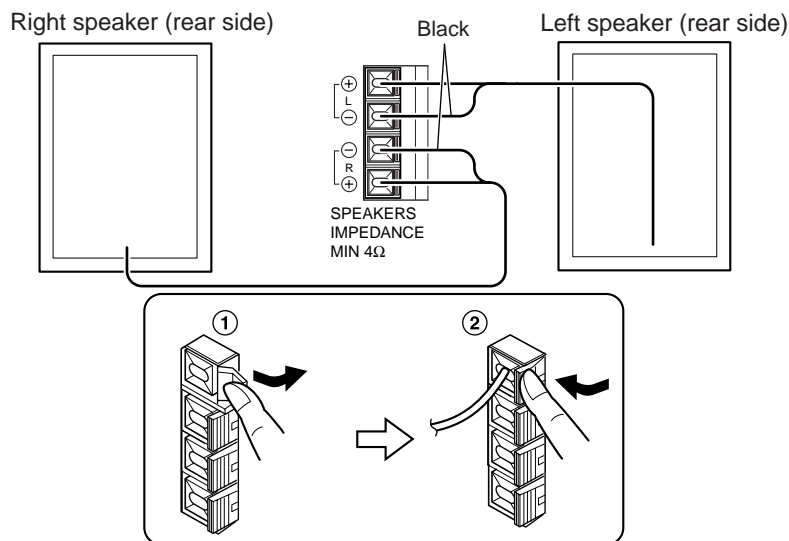

**CAUTION:**

**If a TV is installed near the speakers, the picture on the TV may be distorted. If this happens, set the speakers away from the TV.**

## Connecting External Equipment

You can connect an audio equipment — used only as a playback device.

Connect the audio output terminals on the other equipment and the LINE IN (AUX) terminals on the rear, using an audio cord (not supplied).

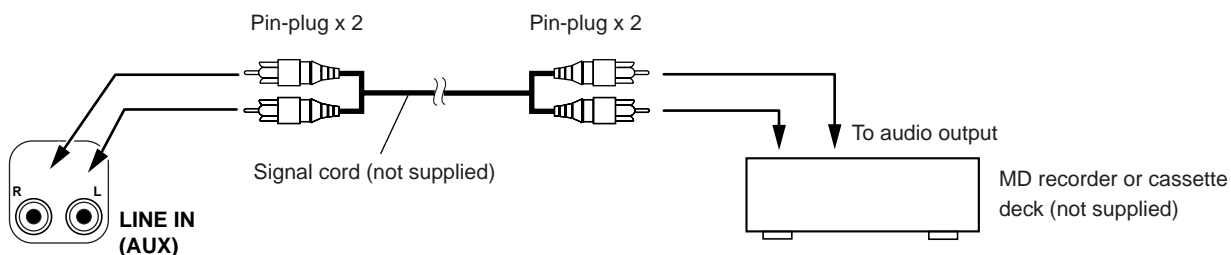





## Connecting the AC Power Cord

Firmly insert the supplied AC power cord into the AC inlet on the back of the Unit.

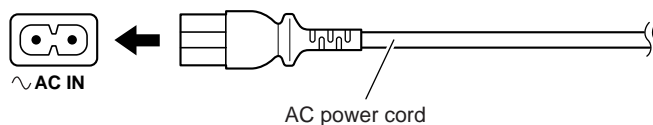

### CAUTIONS:

- **ONLY USE JVC POWER CORD PROVIDED WITH THIS SYSTEM TO AVOID MALFUNCTION OR DAMAGE TO THE SYSTEM.**
- **BE SURE TO UNPLUG THE POWER CORD FROM THE OUTLET WHEN YOU ARE GOING OUT OR WHEN THE SYSTEM IS NOT IN USE FOR AN EXTENDED PERIOD OF TIME.**

**Now you can plug the AC power cord into the wall outlet, and your System is at your command!**

## COMPU PLAY

The JVC's COMPU PLAY feature lets you control the most frequently used System functions with a single touch. With One Touch Operation you can play a CD, a tape, turn on the radio, or listen to an external equipment at a single press of the play button for that function. One Touch Operation turns the power on for you, then starts the function you have specified. How One Touch Operation works in each case is explained in the section dealing with that function. The COMPU PLAY buttons are:

### On the Unit

CD ▷/|| button  
 FM/AM button  
 TAPE ◀▷ button  
 AUX button

### On the Remote Control

CD ▷/|| button  
 FM/AM button  
 TAPE ◀▷ button  
 AUX button

## AUTOMATIC POWER ON

The System automatically turns on with the following operation.

- When you press the CD OPEN/CLOSE ▲ button on the Unit (or CD ▲ button on the Remote Control), the System automatically turns on and the CD cover opens to allow CD insertion. However, this operation does not change the source to CD. When you press the ⏻ button to turn on or off the System, the CD cover will automatically close if it is open.



# Common Operations

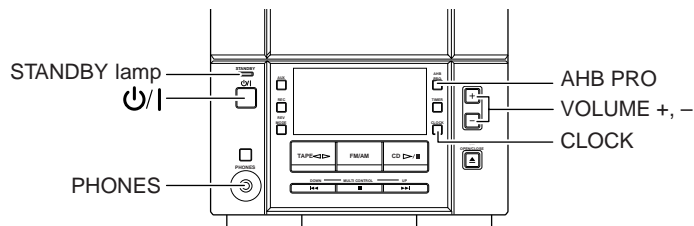
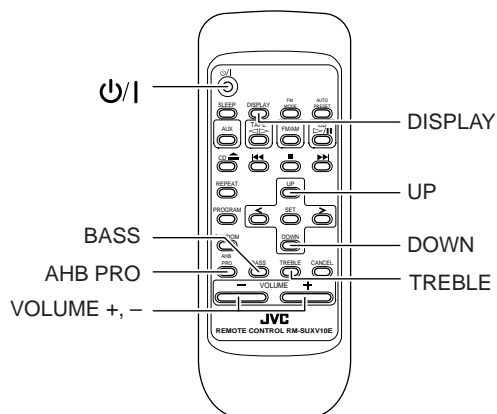

## Turning the Power On and Off

### Turning the System on

**Press the P/I button.**

The STANDBY lamp goes out.

The System comes on ready to play the source it was for when the power was last turned off.

- For example, if the last thing you were doing was listening to a CD, you are now ready to listen to a CD again. If you wish, you can change to another source.
- If you were listening to the Tuner last, the Tuner comes on playing the station it was last set to.

### Turning the System off

**Press the P/I button again.**

The STANDBY lamp lights up.

- Some power is always consumed even though power is turned off (called Standby Mode).
- To switch off the System completely, unplug the AC power cord from the wall outlet. When you unplug the AC power cord, the clock will be reset to 0:00.

## Adjusting the Volume

Press the VOLUME + button to increase the volume or press the VOLUME - button to decrease it.

VOLUME 15

You can adjust the volume level between 0 and 40.

### CAUTION:

**DO NOT turn off (on standby) the Unit with the volume set to an extremely high level; otherwise a sudden blast of sound could damage your hearing, speakers and/or headphones when you turn on the Unit or start playing any source next time.**

**REMEMBER you cannot adjust the volume level while the Unit is on standby.**

### For private listening

Connect a pair of headphones to the PHONES jack. No sound comes out of the speakers.

Be sure to turn down the volume before connecting or putting on headphones.





## Reinforcing the Bass Sound (AHB PRO)

You can reinforce the bass sound to maintain rich, full bass at low volume (you can use this effect only for playback):

**To get the effect**, press the AHB (Active Hyper Bass) PRO button.

The BASS indicator lights up on the display.

**To cancel the effect**, press the button again.

The BASS indicator goes out.

## Controlling the Tone (Bass/Treble)

You can control the tone by changing the bass and treble.

### Adjusting the bass level

You can adjust the bass level (low frequency range level) between -5 and +5. (0: Flat)

**1 Press the BASS button on the Remote Control.**

**2 Press the UP or DOWN button on the Remote Control to adjust the bass level.**



### Adjusting the treble level

You can adjust the treble level (high frequency range level) between -5 and +5. (0: Flat)

**1 Press the TREBLE button on the Remote Control.**

**2 Press the UP or DOWN button on the Remote Control to adjust the treble level.**



## Showing the Clock Time

In Standby mode, the digital clock appears on the display.

When the System is turned on, you can display the digital clock any time.

**To display the digital clock**, press the CLOCK button on the Unit or DISPLAY button on the Remote Control.

12:00

**To return to the previous mode**, press the same button again.

**Note:** To let the clock work, you need to set the clock beforehand. (See "Setting the Clock" on page 17.)



# Using the Tuner

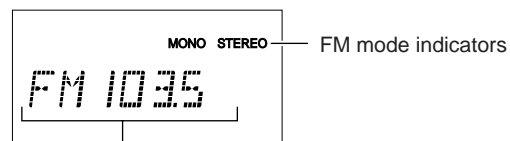
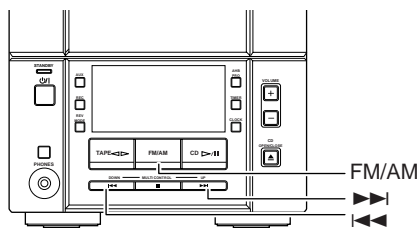
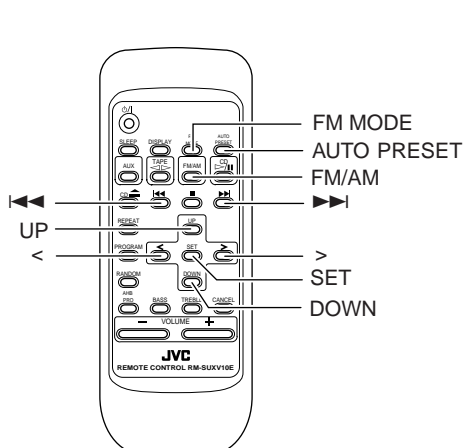

Band display, Frequency display, Preset channel

When the System is in use, the display shows other items as well. For simplicity, only the items described in this section are shown here.

You can listen to FM and AM (MW/LW) stations. Stations can be tuned in manually, automatically, or from preset memory storage.

- Before listening to the radio:
  - Make sure that both the FM and AM (MW/LW) antennas are correctly connected. (See page 3.)

## One touch radio

Just press the FM/AM button to turn on the System and start playing the station you were last tuned to.

- You can switch from any other sound source to the radio by pressing the FM/AM button.

OR

- **Preset Tuning using the Remote Control (Possible only after presetting stations)**

Select the desired preset number using the UP, DOWN, > or < button on the Remote Control. After 1 second the display will show the preset number's band and frequency.

Example: Press the UP button until the preset number 12 "P-12" appears.

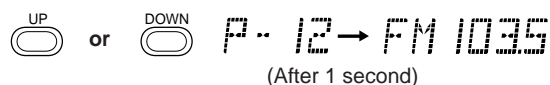

## Tuning In a Station

### 1 Press the FM/AM button.

The band and frequency you were last tuned to appear on the display.

(If the last station was selected using the preset number, the preset number appears first.)

Each time you press the button, the band alternates between FM and AM (MW/LW).

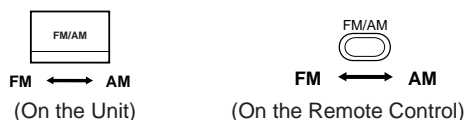

### 2 Select a station using one of the following methods.

#### Manual Tuning

Press the << or >> button repeatedly to move from frequency to frequency until you find the station you want.

OR

#### Auto Tuning

If you press and hold the << or >> button for one second or more, the frequency changes down, or up, automatically until a station is found.

## Presetting Stations

You can preset up to 30 FM stations and up to 15 AM (MW/LW) stations using the Remote Control.

**Note:** Preset numbers may have been set to factory test frequencies prior to shipment. This is not a malfunction.

You can preset the stations you want into memory by following one of the presetting methods below.

### Presetting stations manually

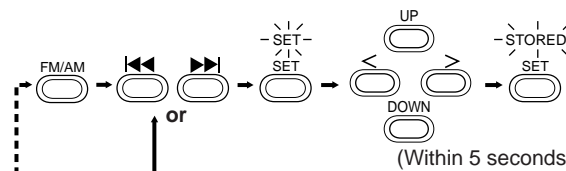

When changing the Band FM = 30, AM = 15

#### 1 Select a band by pressing the FM/AM button.

#### 2 Press the << or >> button to tune in a station.

#### 3 Press the SET button.

"SET" will flash for 5 seconds.

Within 5 seconds, proceed to the next step.

When the display returns to the one set in Step 2 after 5 seconds, press the SET button again.





**4 Press the UP, DOWN, >, or < button within 5 seconds to select the preset number.**

UP or > button: Increases the preset number by 1.

DOWN or < button: Decreases the preset number by 1.

- When the > or < button is held down, the preset number changes rapidly.

**5 Press the SET button within 5 seconds.**

“STORED” appears and after 2 seconds, the display returns to the broadcast frequency display.

**6 Repeat above steps 1 to 5 for each station you want to store in memory with a preset number.**

To change the preset stations, repeat the same steps as above.

**Presetting stations automatically —**

In each band, you can automatically preset 30 FM and 15 AM (MW/LW) stations. Preset numbers will be allocated as stations are found, starting from the lowest frequency and moving up the frequency.

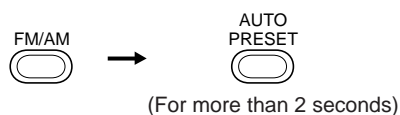

**1 Select a band by pressing the FM/AM button.**

**2 Press the AUTO PRESET button on the Remote Control for more than 2 seconds.**

**3 Repeat steps 1 – 2 for the other band.**

- If you want to change the preset stations, carry out the Manual Presetting for the desired preset numbers.

**CAUTION:**

**Even if the system is unplugged or if a power failure occurs, the preset stations will be stored for about 24 hours. However, in case the preset stations are erased, you will need to preset the stations again.**

## Changing the FM Reception Mode

When you have tuned into an FM stereo broadcast, the STEREO indicator lights up and you can hear stereo effects.

If an FM stereo broadcast is hard to receive or noisy, you can select Monaural mode. Reception improves, but you lose any stereo effect.

**Press the FM MODE button on the Remote Control so that the MONO indicator lights up on the display.**



STEREO ↔ MONO

To restore the stereo effect, press the FM MODE button on the Remote Control so that the MONO indicator goes off.





# Using the CD Player

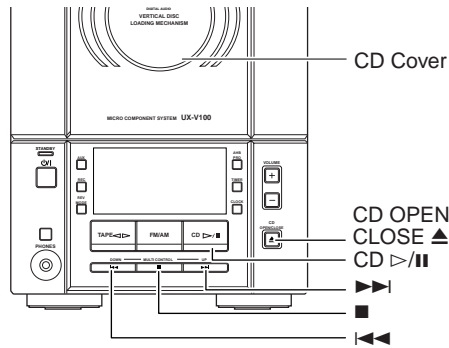
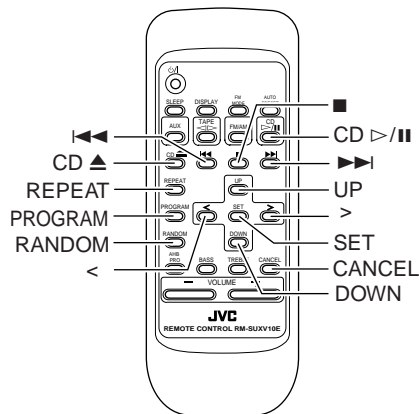

Track number, Playing time,  
Program order number

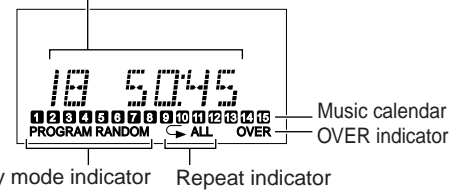

When the System is in use, the display shows other items as well.  
For simplicity, only the items described in this section are shown here.

Track number exceeding  
15 is not displayed.

You can use Normal, Random, Program or Repeat Play. Repeat Play can repeat all the tracks or just one of the tracks on the CD. Here are the basic things you need to know to play a CD and locate the different tracks on it.

## The quickest way to start a CD is with the one touch operation

- Press the CD >/|| button on the Unit or the Remote Control.
  - The power is automatically turned on. If a CD is already inserted, it will start playing from the first track.
  - If no CD is inserted, "NO DISC" appears on the display and the CD Player remains in Stop mode.

## Inserting a CD

- 1 Press the CD OPEN/CLOSE ▲ button on the Unit (or the CD ▲ button on the Remote Control).**

The CD cover opens.

- 2 Place a CD, with its label side out as shown below. Press down on the portions around the CD's center hole until you hear a click.**

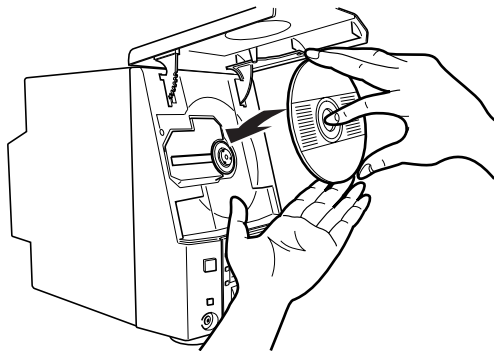

- 3 Press the CD OPEN/CLOSE ▲ button on the Unit (or the CD ▲ button on the Remote Control) again to close the CD cover.**

- To close the CD cover and play the CD, you can just press the CD >/|| button.
- You can place an 8 cm CD without an adaptor.
- When a CD with 16 tracks or more is loaded, the OVER indicator will light up on the display.
- If the CD cannot be read correctly (because it is scratched, for example), "00 0000" appears on the display.
- You can insert a CD while listening to another source.

## CAUTIONS:

- **DO NOT try to open or close the CD cover by hand as it will be damaged.**
- **When you place or take out a CD, do not let it fall. Be careful not to scratch your fingers with the CD cover.**

## Unloading a CD

Take out the CD as shown below.

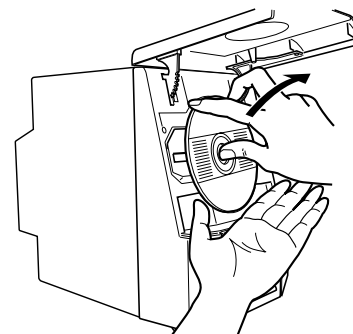



## Basics of Using the CD Player — Normal Play

### Playing a CD

#### 1 Insert a CD.

#### 2 Press the CD ▷/|| button.

The first track of the CD begins playing.

01 0005  
Track number      Playback time

- The track number that has already played disappears from the music calendar.
- The CD Player automatically stops when the last track of the CD has finished playing.

To stop playing the CD, press the ■ button.  
The following information for the CD is displayed.

18 5045  
Total track number      Total playback time

To stop playing and remove the CD, press the CD OPEN/CLOSE ▲ button on the Unit or CD ▲ button on the Remote Control to open the CD cover. Then remove the CD.

To pause, press the CD ▷/|| button. The playback time flashes on the display.

To cancel pause, press the same button again. Play continues from the point where it was paused.

### Selecting a track

During playback, press the ◀◀ or ▶▶ button (or the </>/DOWN/UP button on the Remote Control) to select the track you want.

The selected track starts playing.

- Press the ▶▶ button (or the >/UP button on the Remote Control) once to skip to the beginning of the next track.
- Press the ◀◀ button (or the </DOWN button on the Remote Control) to skip to the beginning of the track being played. Press twice quickly to skip to the beginning of the previous track.
- When the > or < button on the Remote Control is held down, the tracks are successively skipped.

### Selecting a passage within a track

Holding down the ◀◀ or ▶▶ button (or the DOWN/UP button on the Remote Control), during playback, will fast-forward/reverse the CD so you can quickly find a particular passage in the track you are listening to.

## Programming the Playing Order of the Tracks

You can program the playing order of the tracks using the Remote Control.

- You can program up to 20 tracks in any desired order including the same tracks.
- You can only make a program when the CD Player is stopped.

#### 1 Insert a CD.

#### 2 Press the CD ▷/|| button.

#### 3 Press the ■ button to stop the CD.

#### 4 Press the PROGRAM button.

The System enters the programming mode and the PROGRAM indicator lights up.



#### 5 Press the > or < button to select the track to program.

> button: Increases the track number by 1.

< button: Decreases the track number by 1.

- When the > or < button is held down, the track number changes rapidly.

#### 6 Press the SET button.

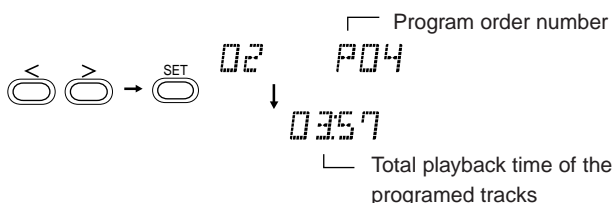

#### 7 Repeat steps 5 and 6 to select the other tracks for the program.

You can see the total playback time of programmed tracks on the display. You can also see the programmed tracks on the music calendar.

#### 8 Press the CD ▷/|| button.

The System plays the tracks in the order you have programmed them.

- You can skip to a particular program track by pressing the ◀◀ or ▶▶ button (or the </>/DOWN/UP button on the Remote Control) during Program Play.

- To stop playing, press the ■ button once.

To confirm the programmed tracks while the CD player is stopped, press the PROGRAM button; the tracks making up the program will successively be displayed in the programmed order.

To delete all the tracks in the program while the CD player is stopped, press the ■ button. Pressing the CD ▲ button on the Remote Control (or the CD OPEN/CLOSE ▲ button on the Unit) to open the CD cover will also clear the programmed tracks.

To exit from the program mode while the CD player is stopped, press the ■ button to light off the PROGRAM indicator. All the programmed tracks will be cleared.

#### Notes:

- If the total playback time of the programmed tracks exceeds 99 minutes 59 seconds, "-- : --" appears on the display.
- If you try to program the 21st track, "FULL" appears on the display for about 2 seconds.

### Modifying the program

Modify the contents of the program while the CD Player is stopped. Each time you press the CANCEL button, the last track in the program is deleted. To add new tracks to the end of the program, repeat above steps 5 to 7.



## Playing at Random

The tracks will play in no particular order when you use this mode.

### Press the **RANDOM** button on the Remote Control.

The RANDOM indicator lights up on the display, and tracks will be played in random order.

**To skip a track during playback**, press the ►► button (or the >/UP button on the Remote Control) to jump to the next randomly selected track. Press the ◀◀ button (or the </DOWN button on the Remote Control) to jump back to the start of a track being played.

**To exit from Random Play mode**, press the ■ button.

## Repeating Tracks

You can set the program or individual track currently playing to repeat as many times as you like.

### Press the **REPEAT** button on the Remote Control.

The Repeat indicator changes at each press of the button, as shown below.



↶ : Repeats one track.

↶ ALL : In Normal Play mode, repeats all the tracks.  
In Program Play mode, repeats all the tracks in the program.  
In Random Play mode, repeats all the tracks in random order.

**To exit from Repeat mode**, press the REPEAT button until the Repeat indicator on the display goes out.

■ In Random Play ↶ cannot be selected.

■ Repeat mode remains in effect even when you change the play mode.

## Locking the CD cover

You can lock the CD cover and prohibit to unload the CD.

- This operation is possible only using the buttons on the unit.

**To prohibit unloading the CD**, press the ⏻/I button while holding the ■ button. (If the CD cover is opened, close it first.) “LOCKED” appears for a while, and the CD cover is locked.

**To cancel the prohibition and unlock the CD cover**, press the ⏻/I button while holding the ■ button. “UNLOCKED” appears for a while, and the CD cover is unlocked.

**Note:** If you try to unload the CD, “LOCKED” appears to inform you that the CD cover is locked.



# Using the Cassette Deck (Listening to a Tape)

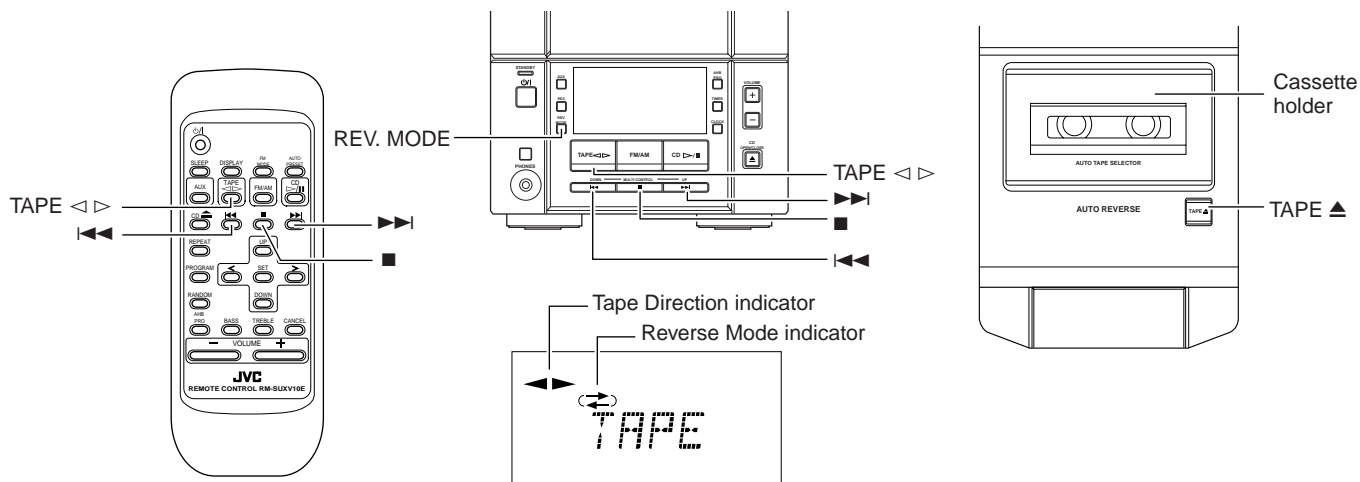

When the System is in use, the display shows other items as well. For simplicity, only the items described in this section are shown here.

The Cassette Deck allows you to play and record audio tapes.  
 ■ With Automatic Tape Detection, you can listen to type I, II or IV tapes without having to change any settings.

The use of tapes longer than 120 minutes is not recommended, since characteristic deterioration may occur and these tapes easily jam in the pinch-rollers and the capstans.

## One touch play

By pressing the TAPE <> button on the Unit or the Remote Control, the Unit will come on, "TAPE" appears on the display, and if a tape is in the deck, it will start to play. If no tape is loaded, the Unit will come on and wait for you to insert a tape, or select another function.

## Standard Play

When the power is already on, you can use this basic procedure:

- 1 Press the TAPE ▲ button on the Unit.**
- 2 When the cassette holder opens, put the cassette in, with the side you want to listen to facing up.**
  - If the cassette holder does not open, turn the Unit off, then back on and press the TAPE ▲ button again.

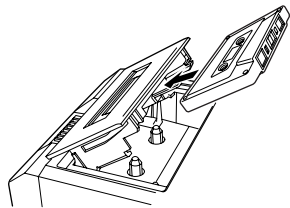

- 3 Close the holder gently until it clicks.**

- 4 Press the TAPE <> button.**

The tape is played in the direction shown by the Tape Direction indicator.

- 5 If you need to change the playback direction, press the TAPE <> button again.**

The other Tape Direction indicator lights up and the tape playback direction changes.

To stop playing, press the ■ button.

To remove the tape, stop the tape, and press the TAPE ▲ button on the Unit.

## Fast-winding a tape

- Press the ►► or ◀◀ button to fast-wind the tape.
  - The Cassette Deck automatically stops when the tape reaches its end.

## Reverse Mode

You can set the cassette deck to play just one side of a tape, both sides once, or both sides continuously.

**Press the REV. (reverse) MODE button on the Unit.**

The indicator changes at each press of the button as shown.

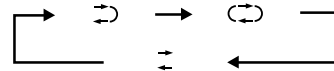

- ↔ : The Cassette Deck automatically stops after playing both sides of the tape. (Stops when playback in the ◀ direction is finished.)
- ↻ : The Cassette Deck continues to play both sides of the tape until the ■ button is pressed.
- : The Cassette Deck automatically stops after playing one side of the tape.



# Using the Cassette Deck (Recording)

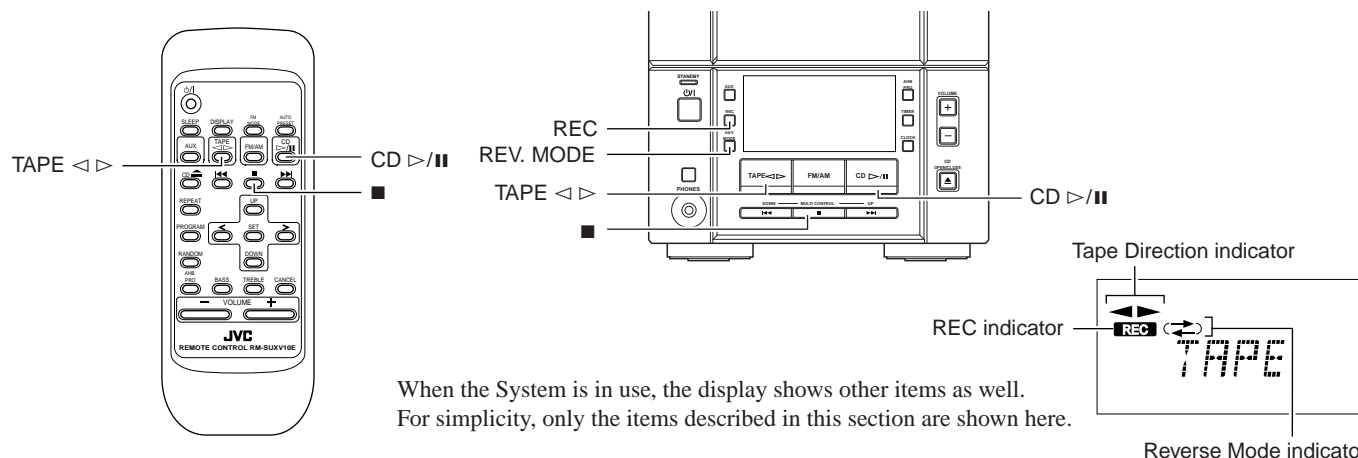

Recording onto a tape from any of the sound sources is simple. Just place a tape in the Cassette Deck, have the source ready, make one or two settings, and you're ready to record. For each source the procedure is a little bit different so we explain each separately. But first, here are a few things to make your recordings better.

## Things to know before you start recording

- It should be noted that it may be unlawful to re-record pre-recorded tapes, records, or discs without the consent of the owner of copyright in the sound or video recording, broadcast or cable program and in any literary, dramatic, musical, or artistic embodied therein.
- When you want to record onto both sides of a tape, you can set Reverse mode to do so. Recording automatically stops after recording in the  $\triangleleft$  direction. Therefore, make sure that the tape direction is  $\triangleright$  when recording with Reverse mode on.
- The recording level, which is the volume at which the new tape is being made, is automatically set correctly, so it is not affected by the VOLUME control on the System. Nor is it affected by adjusting the sound effects. Thus, during recording you can adjust the sound you are actually listening to without affecting the recording level.
- Two small tabs on the back of the cassette tape, one for side A and one for side B, can be removed to prevent accidental erasure or recording.

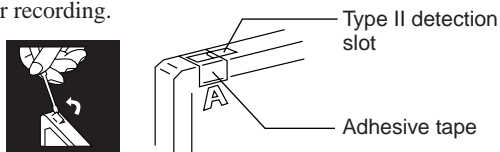

- To record on a cassette with the tabs removed, you must cover the holes with adhesive tape first. However, when a type II tape is used, only cover part of the hole as shown, since the other part of the hole (Type II detection slot) is used to detect the tape type.
- Type I and Type II tapes can be used for recording.

**Note:** At the start and end of cassette tapes, there is leader tape which cannot be recorded onto. Thus, when recording CDs or radio broadcasts, wind on the leader tape first to ensure that the recording will be made without any music part lost.

**CAUTION:**  
If a recording you make has excessive noise or static, the Unit may have been too close to a TV which was on during the recording. Either turn off the TV or increase the distance between the TV and the System.

## Standard Recording

You can record any sound source to tape as follows:

- 1 Insert a blank or erasable tape into the Cassette Deck.**
- 2 If you want to record on both sides of a tape, press the REV. MODE button on the Unit until the  $\triangleleft \triangleright$  indicator is lit.**
  - When using Reverse mode, insert the tape so that it will be recorded in the forward  $\triangleright$  direction.
- 3 Check the recording direction for the tape.**  
Make sure that the Tape Direction indicator is the same as that for the tape in the Cassette Deck. If the directions are different, press the TAPE  $\triangleleft \triangleright$  button to correct the tape direction and then press the  $\blacksquare$  button to stop the tape.
- 4 Prepare the source by, for example, tuning in a radio station or turning on connected auxiliary equipment.**

**Note:** For CD recording, refer to "CD Direct Recording" on page 15.

- 5 Press the REC button on the Unit.**  
The REC indicator lights up and the System begins recording.

**Notes for using Reverse mode for recording**  
When recording in Reverse mode, the System automatically stops when it reaches the end of the reverse  $\triangleleft$  direction. To record on both sides of a tape, make sure that the recording direction for the tape inserted is forwards  $\triangleright$ , and that the Tape Direction indicator is also forwards  $\triangleright$ , before you start recording.

**To stop at any time during the recording process**  
Press the  $\blacksquare$  button.





## CD Direct Recording

Everything on the CD goes onto the tape in the order it is on the CD, or according to the order you have set in a program.

### 1 Insert a blank or erasable tape into the Cassette Deck.

### 2 Insert a CD.

### 3 Press the CD ▷/|| button.

### 4 Press the ■ button.

- If you want to record specific tracks only, program the tracks beforehand. You can check their total playback time on the display during programing. (See page 11.)

### 5 If you want to record on both sides of a tape, press the REV. MODE button on the Unit until the ⇨ indicator is lit.

- Make sure that the recording direction for the tape and the Tape Direction indicator are correct. (See “Notes for using Reverse mode for recording”.)

### 6 Select whether to have pauses left between recorded selections.

- If nothing is done, a non-recorded pause of about four seconds will be automatically left between selections.
- If you do not want pauses left between selections, do the following before proceeding to the next step.

**Press the CD ▷/|| button twice.**

The CD player enters Pause mode.

### 7 Press the REC button on the Unit.

The REC indicator lights up and the System begins recording.

- When recording a CD onto tape with Reverse mode on:
  - If a song is recorded for more than 12 seconds (which corresponds to the length of leader tape) but not finished before the first side of tape comes to an end, this song will automatically be recorded on the second side from its beginning to avoid being split on both sides.
  - If a song is recorded for less than 12 seconds before the first side of tape comes to an end, the song preceding this song will also be recorded on the second side from its beginning as it may not be completely recorded on the first side because of leader tape.
- After the CD player has played the entire CD, or all the programmed tracks, the tape automatically stops.

**To stop at any time during the recording process**, press the ■ button. The tape stops after 4 seconds.

**Note:** When making SLEEP timer settings while doing CD Direct recording, set enough time to allow for the CD to finish playing, otherwise the power will go off before recording is completed.

## One track recording

### 1 Insert a blank or erasable tape into the Cassette Deck.

### 2 Play the track on the CD you wish to record.

### 3 Press the REC button on the Unit.

The CD player returns to the beginning of that track and the track is recorded on the tape. After recording, the CD player and Cassette Deck automatically stop.



# Using External Equipment

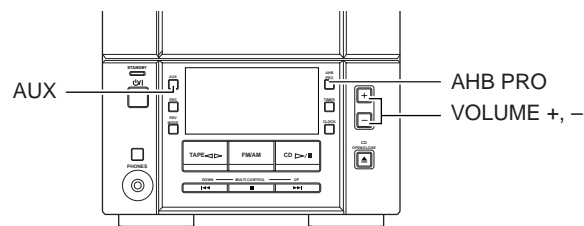
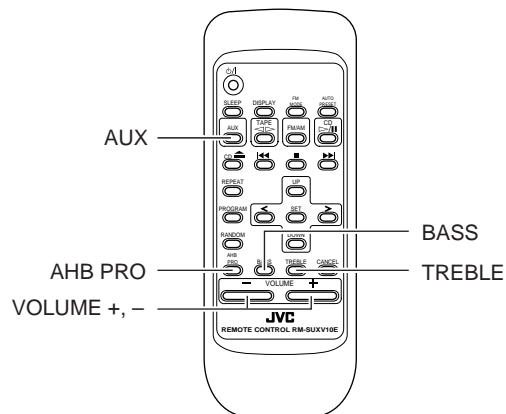

## Listening to External Equipment

You can connect an audio equipment — used only as a playback device.

- First make sure that the external equipment is properly connected to the System. (See page 4.)

### 1 Set the VOLUME control to the minimum position.

### 2 Press the AUX button.

“AUX” appears on the display.

AUX

### 3 Start playing the external equipment.

### 4 Adjust the VOLUME control to the desired listening level.

### 5 Apply sound effects, if you wish.

- Press the AHB PRO button to reinforce the bass sound.
- Press the BASS/TREBLE button on the Remote Control to control the tone. (See “Controlling the Tone (Bass/Treble)” on page 7.)

To exit from AUX mode, select another source.

#### Notes:

- For operation of the external equipment, refer to its Instructions.
- For recording from the external equipment, refer to “Standard Recording” on page 14.





# Using the Timers

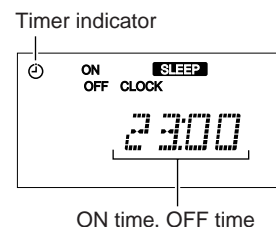
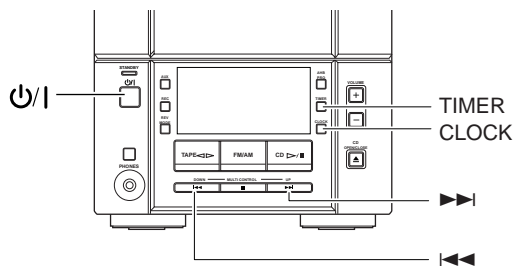
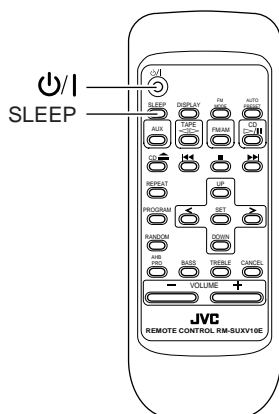

When the System is in use, the display shows other items as well. For simplicity, only the items described in this section are shown here.

The timers let you control listening and recording functions automatically.

## Setting the Clock

- When you plug the AC power cord into the wall outlet, the CLOCK indicator flashes on the display. You can set the clock whether the System is on or off.

### Notes:

- The clock must be correctly set for the timers to work.
- The procedure must be completed within 2 minutes. Otherwise, the setting is cleared and must be repeated from the beginning.

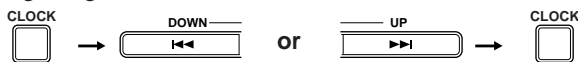

(For 2 seconds)

- 1 Press the CLOCK button on the Unit for more than 2 seconds.**

The hour digits rapidly flash on the display.

- 2 Press the ►► or ◄◄ button to set the hour.**

Pressing the ►► button moves the hour forwards and pressing the ◄◄ button moves it backwards. Hold down the button to move the hour rapidly.

- 3 Press the CLOCK button.**

The minute digits rapidly flash on the display.

- 4 Press the ►► or ◄◄ button to set the minute.**

Pressing the ►► button moves the minute forwards and pressing the ◄◄ button moves it backwards. Hold down the button to move the minute rapidly.

- 5 Press the CLOCK button again.**

The selected time is set and the seconds start counting from 0. The CLOCK indicator remains lit on the display.

### CAUTION:

**If the System is unplugged, or a power failure occurs, the timer setting will be lost. You will need to reset the clock first, then the timer.**

**Note:** The clock may gain or lose 1 to 2 minutes per month.

## Setting the Daily Timer

Once you have set the Daily Timer, the timer will be activated at the same time every day. It can be canceled and re-activate whenever you wish.

The Timer indicator on the display shows when the Daily Timer you have set will be activated.

### Notes:

- Finish each step within 30 seconds. Otherwise, the setting is cleared and the procedure must be repeated from the beginning.
- The clock must be correctly set for the timers to work. If the clock has not been set, the CLOCK indicator will flash on the display when you press the TIMER button for more than 2 seconds, and then the display alternates between "ADJUST" and "CLOCK" for about 5 seconds.

- 1 Press the TIMER button on the Unit for more than 2 seconds.**

The ON indicator lights up, and then the current ON time flashes on the display. (Example: 12:00)

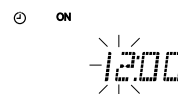

- 2 Set the ON time. (Example: 12:15)**

Press the ►► or ◄◄ button on the Unit to set the hour you want the Unit to come on. Pressing the ►► button moves the hour forwards and pressing the ◄◄ button moves it backwards. Hold down the button to move the hour rapidly. Press the TIMER button to adjust the minute.

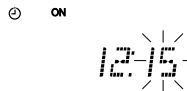

- 3 Set the OFF time. (Example: 13:15)**

1. Press the TIMER button on the Unit. The hour digits of the current OFF time flashes, and then the OFF indicator lights up on the display.

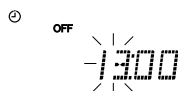

2. Press the ►► or ◄◄ button on the Unit to set the time you want the Unit to be turned off. Pressing the ►► button moves the hour forwards and pressing the ◄◄ button moves it backwards. Hold down the button to move the hour rapidly. Press the TIMER button again to adjust the minute.

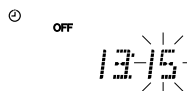



#### 4 Select the music source.

1. Press the TIMER button on the Unit.  
“TUNER” flashes on the display.
2. Press the ►► or ◀◀ button to select the music source you want to listen to.  
The display changes as shown below.

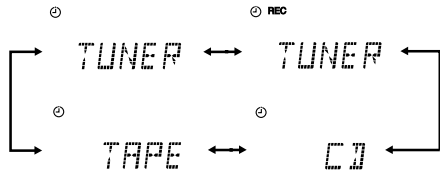

#### 5 Set the volume level.

1. Press the TIMER button on the Unit.  
The current volume setting flashes on the display.
2. Press the ►► or ◀◀ button to select the volume level.  
-- : The current volume level will be used.  
0 to 40 : When the timer is turned on, the Volume will be automatically set to the selected level.



#### 6 Press the TIMER button on the Unit.

The timer setting is completed and the display returns to the indications before you set the timer. The Timer indicator remains lit.

#### 7 Before turning off the System, prepare the music source selected in step 4.

TUNER: Tune in to the desired station.  
REC TUNER: See “Setting the Recording Timer.”  
CD: Insert a CD.  
TAPE: Insert a tape.

#### 8 Press the ⏻ button to turn off the System.

**To cancel the timer,** press the TIMER button for more than 2 seconds. The Timer indicator goes out on the display.  
**To re-activate the canceled timer,** press the TIMER button for more than 2 seconds to light the Timer indicator. Then, press the TIMER button until the display returns to the previous indications. The Timer indicator should remain lit.  
**To confirm the timer settings,** cancel the timer once by pressing the TIMER button, and press the button again for more than 2 seconds. Then, press the TIMER button repeatedly, to see the current timer settings (ON time, OFF time, source, and volume). Press the TIMER button to set the timer again.  
**To change the timer setting,** repeat the setting procedure from the beginning.

- When the timer turns on, the Timer indicator starts flashing.

**Note:** If the Unit is turned on when the timer-on time comes, Daily Timer does not work.

**CAUTION:**  
**If the System is unplugged, or a power failure occurs, the timer will be canceled. You will need to reset the clock first, then the timer.**

## Setting the Recording Timer

With the Recording Timer, you can make a tape of radio broadcast automatically.

#### How Recording Timer actually works

The Unit automatically turns on, tunes into the last received station, and starts recording when the on-time comes. Then, when the off-time comes, the Unit automatically turns off (stands by). The timer setting remains in memory until you change it.

#### Notes:

- Finish each step within 30 seconds. Otherwise, the setting is cleared and the procedure must be repeated from the beginning.
- The clock must be correctly set for the timers to work.  
If the clock has not been set, the CLOCK indicator will flash on the display when you press the TIMER button for more than 2 seconds, and then the display alternates between “ADJUST” and “CLOCK” for about 5 seconds.

#### 1 Press the ⏻ button to turn on the System.

#### 2 Tune in to the desired station.

See page 8.

#### 3 Press the TIMER button on the Unit for more than 2 seconds.

The ON indicator lights up, and then the current ON time flashes on the display. (Example: 12:00)

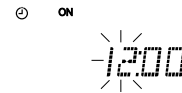

#### 4 Set the ON time. (Example: 12:15)

Press the ►► or ◀◀ button on the Unit to set the hour you want the Unit to come on.  
Pressing the ►► button moves the hour forwards and pressing the ◀◀ button moves it backwards. Hold down the button to move the hour rapidly. Press the TIMER button to adjust the minute.

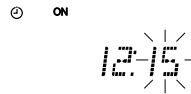

#### 5 Set the OFF time. (Example: 13:15)

1. Press the TIMER button on the Unit.  
The hour digits of the current OFF time flashes, and then the OFF indicator lights up on the display.
2. Press the ►► or ◀◀ button on the Unit to set the time you want the Unit to be turned off.  
Pressing the ►► button moves the hour forwards and pressing the ◀◀ button moves it backwards. Hold down the button to move the hour rapidly. Press the TIMER button again to adjust the minute.

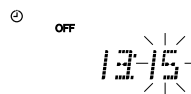

#### 6 Press the TIMER button on the Unit.





**7 Press the ►► or ◄◄ button until “TUNER” appears and the REC indicator lights up on the display.**

The display changes as shown below.

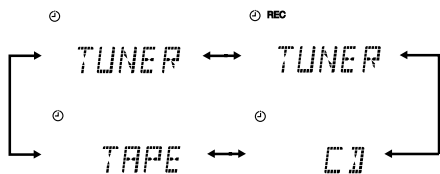

**8 Set the volume level.**

1. Press the TIMER button on the Unit.  
The current volume setting flashes on the display.
2. Press the ►► or ◄◄ button to select the volume level.  
-- : The current volume level will be used.  
0 to 40 : When the timer is turned on, the Volume will be automatically set to the selected level.

**To turn off the volume while the Recording Timer is working,** set the volume level to “0”.

**9 Press the TIMER button on the Unit.**

The timer setting is completed and the display returns to the indications before you set the timer. The Timer indicator remains lit.

**Note:** If you change the station before turning off the System, the last received station will be recorded.

**10 Insert a blank or erasable tape into the Cassette Deck.**

- Make sure that the tape has the enough length for recording.

**11 Press the ⏻/| button to turn off the System.**

- To cancel the timer,** press the TIMER button for more than 2 seconds. The REC and Timer indicators go out on the display.
- To re-activate the canceled timer,** press the TIMER button for more than 2 seconds to light the REC and Timer indicators.
- To confirm the timer settings,** cancel the timer once by pressing the TIMER button, and press the button again for more than 2 seconds. Then, press the TIMER button repeatedly, to see the current timer settings (ON time, OFF time, source, and volume). Press the TIMER button to set the timer again.
- To change the timer setting,** repeat the setting procedure from the beginning.
- When the timer turns on, the Timer indicator starts flashing.

**Note:** If the Unit is turned on when the timer-on time comes, Recording Timer does not work.

**CAUTION:**  
**If the System is unplugged, or a power failure occurs, the timer will be canceled. You will need to reset the clock first, then the timer.**

**Setting the Sleep Timer**

When a source is playing, use the Sleep Timer to turn the System off after a certain number of minutes. By setting the Sleep Timer, you can fall asleep to music and know that your System will turn off by itself rather than play all night.

- You can only set the Sleep Timer when the System is on.

**Note:** The clock must be correctly set for the timers to work. If the clock has not been set, the CLOCK indicator will flash on the display when you press the TIMER button for more than 2 seconds, and then the display alternates between “ADJUST” and “CLOCK” for about 5 seconds.

**1 Play a CD or a cassette tape, or tune in to the desired station.**

**2 Press the SLEEP button on the Remote Control.**

The SLEEP indicator lights up.

**3 Set the length of time you want the source to play before shutting off.**

- Each time you press the SLEEP button, it changes the number of minutes shown on the display in this sequence:

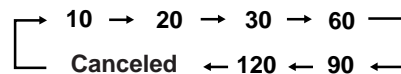

After setting the number of minutes for the Sleep Timer, the display will stop flashing and return to the previous state. The System is now set to turn off after the number of minutes you set.

**To confirm the Sleep Time**

When the SLEEP button is pressed, the remaining sleep time is displayed.

**To cancel the Sleep Timer setting**

Press the SLEEP button until the SLEEP indicator goes out on the display.  
Turning off the System also cancels the Sleep Timer.



# Care and Maintenance

Handle your CDs carefully, and they will last a long time.

## Compact Discs



- Only CDs bearing this mark can be used with this System. However, continued use of irregular shape CDs (heart-shape, octagonal, etc.) can damage the System.

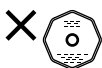

- Remove the CD from its case by holding it at the edges while pressing the case's center hole lightly.
- Do not touch the shiny surface of the CD, or bend the CD.

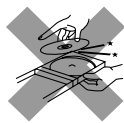

- Put the CD back in its case after use to prevent warping.
- Be careful not to scratch the surface of the CD when placing it back in the case.
- Avoid exposure to direct sunlight, temperature extremes, and moisture.



- A dirty CD may not play correctly. If a CD does become dirty, wipe it with a soft cloth in a straight line from center to edge.

**CAUTION: Do not use any solvent (for example, conventional record cleaner, spray thinner, benzine, etc.) to clean a CD.**

## General Notes

In general, you will have the best performance by keeping your CDs and the mechanism clean.

- Store CDs in their cases, and keep them in cabinets or on shelves.
- Keep the system's CD cover closed when not in use.

## Cleaning the Lens

If the lens in the CD pickup is dirty, sound degradation may take place.

Open the CD cover and clean the lens as shown.

- Use a blower (available from a camera store) to blow dust off the lens.

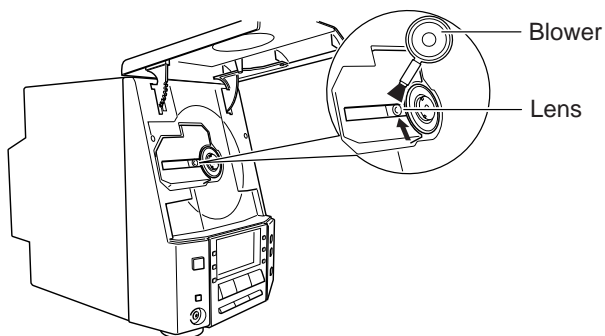

- If there are fingerprints, etc. on the lens, gently wipe clean with a cotton swab.

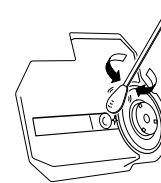

## Moisture Condensation

Moisture may condense on the lens inside the System in the following cases:

- After turning on heating in the room
- In a damp room
- If the System is brought directly from a cold to a warm place

Should this occur, the System may malfunction. In this case, leave the System turned on for a few hours until the moisture evaporates, unplug the AC power cord, and then plug it in again.



## Cassette Tapes



- If the tape is loose, it may get stretched, cut, or caught in the cassette. Take up the slack by inserting a pencil in one of the reels and rotating.



- Do not touch the tape surface.



- Do not store the tape:
  - In dusty places
  - In direct sunlight or heat
  - In moist areas
  - On a TV or speaker
  - Near a magnet

## Cassette Deck

- If the heads, capstans, or pinch-rollers of the Cassette Deck become dirty, the following may occur:
  - Loss of sound quality
  - Discontinuous sound
  - Fading
  - Incomplete erasure
  - Difficulty in recording
- Clean the heads, capstans, and pinch-rollers using a cotton swab moistened with alcohol.

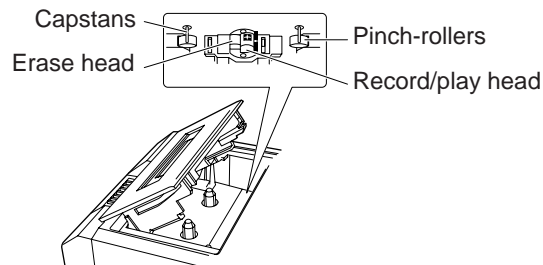

- If the heads become magnetized, the Unit will produce noise or lose high frequency notes.
- To demagnetize the heads, turn off the Unit, and use a head demagnetizer (available at electronics and record shops).







# Troubleshooting

- If you are having a problem with your System, check this list for a possible solution before calling for service.
- If you cannot solve the problem from the hints given here, or the System has been physically damaged, call a qualified person, such as your dealer, for service.

Symptom	Possible Cause	Action
No sound is heard.	<ul style="list-style-type: none"> <li>• Connections are incorrect, or loose.</li> <li>• Headphones are connected.</li> </ul>	<ul style="list-style-type: none"> <li>• Check all connections and make corrections. (See pages 2 – 5.)</li> <li>• Disconnect the headphones.</li> </ul>
Poor radio reception	<ul style="list-style-type: none"> <li>• Antennas are disconnected.</li> <li>• The AM Loop Antenna is too close to the System.</li> <li>• The FM Wire Antenna is not properly extended and positioned.</li> </ul>	<ul style="list-style-type: none"> <li>• Reconnect the antenna securely.</li> <li>• Change the position and direction of the AM Loop Antenna.</li> <li>• Extend FM Wire Antenna to the best reception position.</li> </ul>
The CD does not play.	The CD is upside down.	Put the CD in with the label side up.
The CD skips.	The CD is dirty or scratched.	Clean or replace the CD.
The CD cover does not open or close.	The AC power cord is not plugged in.	Plug the AC power cord.
The cassette holder cannot be opened.	During tape playing, the power cord was unplugged.	Plug in the power cord, press the <b>⏻/ </b> button, and then press the <b>TAPE ▲</b> button.
Unable to record.	Cassette record protect tabs are removed.	Cover the holes on the back edge of the cassette with adhesive tape.
Operations are disabled.	The built-in microprocessor has malfunctioned due to external electrical interference.	Unplug the System then plug it back in.
Unable to operate the Remote Control.	<ul style="list-style-type: none"> <li>• The path between the Remote Control and the sensor on the Unit is blocked.</li> <li>• The batteries have lost their charge.</li> </ul>	<ul style="list-style-type: none"> <li>• Remove the obstruction.</li> <li>• Replace the batteries.</li> </ul>

# Specifications

## UX-V100 (CA-UXV100 and SP-UXV100)

### Amplifier

**Output Power** 44 W (22 W + 22 W) at 4  $\Omega$  (Max.)  
40 W (20 W + 20 W) at 4  $\Omega$  (10% THD)

### Input Sensitivity/Impedance (1 kHz)

LINE IN (AUX) 400 mV/48 k $\Omega$   
**Speaker terminals** 4  $\Omega$  - 16  $\Omega$   
**Phones** 16  $\Omega$  - 1 k $\Omega$   
0 mW - 15 mW per channel output into 32  $\Omega$

### Cassette Deck

**Frequency Response**  
Type I (Normal) 50 Hz - 14 kHz  
Type II (CrO<sub>2</sub>) 50 Hz - 15 kHz  
**Wow and Flutter** 0.15% (WRMS)

### CD Player

**Signal-To-Noise Ratio** 90 dB  
**Wow And Flutter** Immeasurable

### Tuner

**FM Tuner**  
Tuning Range 87.5 MHz - 108.0 MHz  
**AM Tuner**  
Tuning Range (MW) 522 kHz - 1 629 kHz  
(LW) 144 kHz - 288 kHz

### Speaker Specifications

(each unit)  
**Speakers** 8 cm cone  $\times$  1  
**Impedance** 4  $\Omega$   
**Dimensions** 140 mm  $\times$  230 mm  $\times$  211 mm (W/H/D)  
**Mass** Approx. 1.8 kg

### General

**Dimensions** 438 mm  $\times$  234 mm  $\times$  279 mm (W/H/D)  
**Mass** Approx. 6.8 kg

### Power Specifications

**Power Requirements** AC 230 V  $\sim$ , 50 Hz  
**Power Consumption** 50 W (power on mode)  
3.7 W (in Standby mode)

### Accessories

See page 2.

*Design and specifications are subject to change without notice.*

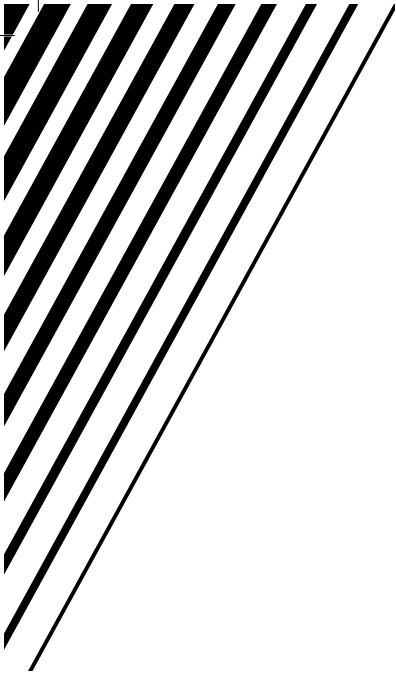

**JVC**  
 VICTOR COMPANY OF JAPAN, LIMITED

